

Technical Data Sheet

Wall Support - Heavy Duty Mounting Angle
Hot Dip Galvanized According To EN ISO 1461



Master Data

| | |
|--------------------|---|
| Product Code | 078.SA100100 |
| Description 1 | Wall Support |
| Description 2 | Heavy Duty Mounting Angle |
| Dimension | 100 x 100mm |
| Material | Steel |
| Surface Protection | Hot Dip Galvanized Steel According To EN ISO 1461 |
| Use | Outdoor / Wet Indoor Facilities |
| F in KN | 1.50 KN |

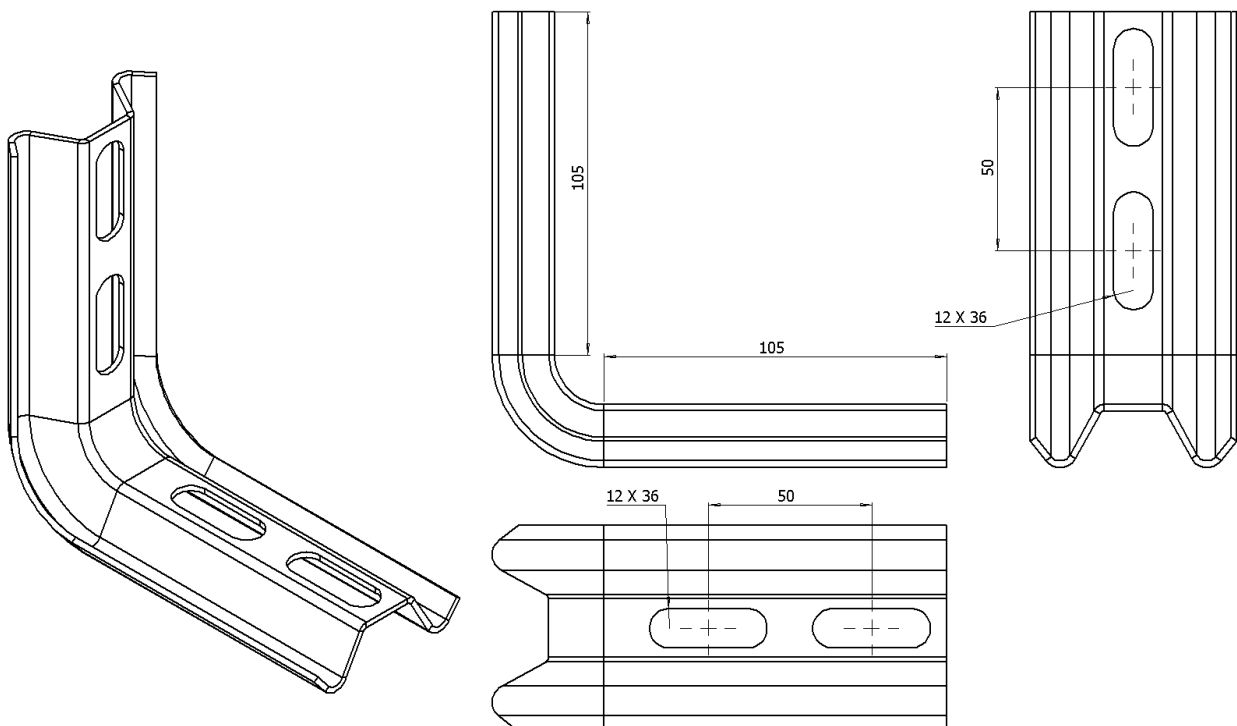

ISO 9001:2015